



CONCEALED CISTERN
AND
FLUSHING SYSTEM
PRODUCT CATALOGUE



20
22

INSPIRING *flow*

SINCE

19
86

ABOUT US

JAPAR was founded in 1986 as a limited company. We are a leading manufacturer and designer of concealed cisterns, flushing cisterns, fill valves, internal mechanisms, toilet seats, bath and floor drains. The Japar product range is enlarging thanks to the research and development activities.

Japar provides a lot of advantages for its customers, such as:

- *Japar promises short lead time in production and product development because the injection molding machines and the duroplast presses as well as the mold shop are in house.*
- *Japar's Quality Management System is certified ISO 9001:2015 by TÜV.*
- *Japar's fill valve is certified by KIWA.*
- *Japar's toilet seats are certified NF by CSTB.*
- *Japar's facility is located 30 km away from Turkey's biggest seaport which provides big logistic advantages.*

Our aims are not limited to expansion and modernizing only, rather we mean to further develop JAPAR's high-quality, reliable and functional products to compete successfully in the global market.

Our latest invention is the Sense Concealed Cistern.

A concealed cistern which operates with Touch-Free sensor control, provides 3/6 L discharge. We added the following advantages; Hygienic, robust against vandalism, different glass designs, works with batteries - 100.000 cycles / guarantee.



QUALITY CERTIFICATES

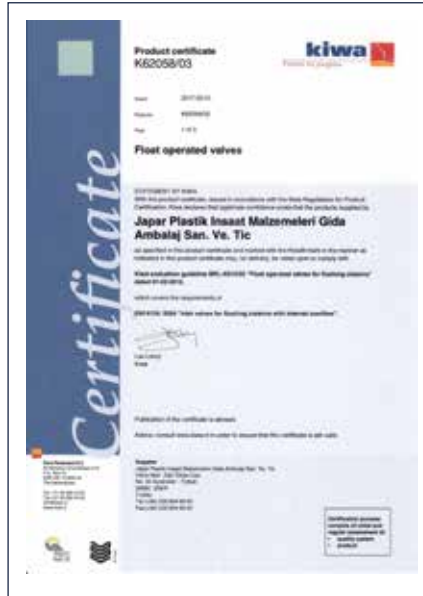

In the Japar factory, production is made in accordance with world standards and environmental responsibility. Every product produced passes the required quality tests before it reaches the customer.

2 YEARS WARRANTY



SILENT



TOUCH - FREE!



PROGLASS SENSE TOUCH - FREE

● 590010

○ 590011

- Touch-Free System
- Concealed cistern frame, tested with 400 kg weight
- Battery usage for flush function
- Battery life: Guaranteed to work 100.000 cycles with 4 x D type batteries
- Simple battery switch
- Adjustable Dual Flush;
Full Flush: 4l to 6l
Half flush: 2l to 3l
- Environmentally friendly design
- %100 leakage test
- Back flow protection, silent filling(16 db),
16 bar pressure resistant, quick stop filling valve,
according EN 14124, Class I
- NF certified filling valve.
- Compatible with wall-hung WC pans only
- Stop valve is optional

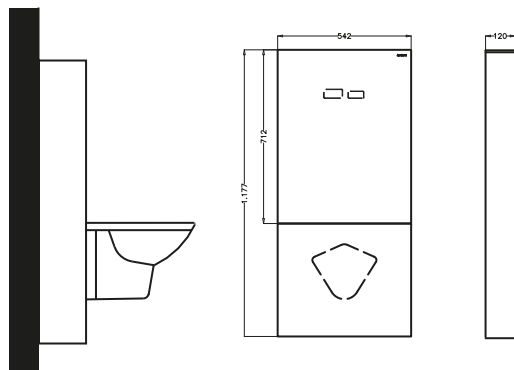

2 YEARS WARRANTY



SILENT



PROGLASS TOUCH

● 590207

- Concealed cistern frame, tested with 400 kg weight
- Adjustable Dual Flush;
Full Flush: 4l to 6l,
Half flush: 2l to 3l
- Environmentally friendly design
- %100 leakage test
- Back flow protection, silent filling(16 db),
16 bar pressure resistant, quick stop filling valve,
according EN 14124, Class I
- NF certified filling valve
- Compatible with wall-hung WC pans only
- Stop valve is optional

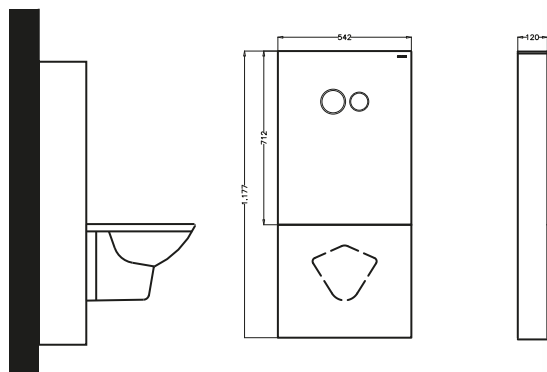

5 YEARS WARRANTY



EASY INSTALLATION



SILENT

51028 •
 PROMICRO CONCEALED CISTERN,
 IN WALL SYSTEM, FOR WALL HUNG WC (80 MM)

51023 (SENSE) •
 SENSE PROMICRO CONCEALED CISTERN,
 IN WALL SYSTEM, FOR WALL HUNG WC (80 MM)

- CE, EN 14055 Quality certificate
- Galvanized frame for brick wall application, tested at 400 kg (EN 997).
- Dual flush concealed cistern, 80 mm thickness
- Adjustable Dual Flush;
 Full Flush: 4l to 6l,
 Half flush: 2l to 3l
- NF approved stop valve with 10 years warranty
- 10 years warranty for Flexible hoses, approved by KIWA and WRAS.
- Successful leakage and pressure tests, Styrofoam insulation against condensation.
- Pre-assembled discharge elbow \varnothing 90 mm with reducer \varnothing 100 or \varnothing 110 mm.
- Silent hydraulic fill valve (16 dB) - EN 14124, Class I
- NF certified filling valve
- 5 years guarantee, except rubber parts
- Without control plate

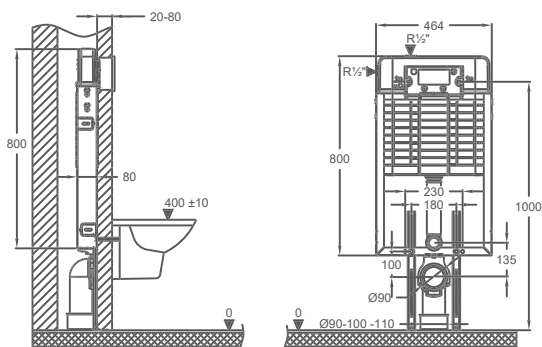

CONCEALED CISTERNS



promicro

5 YEARS WARRANTY



EASY INSTALLATION



SILENT

51030 •

PROMICRO CONCEALED CISTERN, WALL MOUNTED SYSTEM, DRYWALL APPLICATION, FOR WALL HUNG WC (80 MM)

51025 •

SENSE PROMICRO CONCEALED CISTERN, WALL MOUNTED SYSTEM, DRYWALL APPLICATION, FOR WALL HUNG WC (80 MM)

- CE, EN 14055 Quality certificate
- Supporting frame for drywall application, tested at 400 kg (EN 997).
- Dual flush concealed cistern, 80 mm
- Adjustable Dual Flush;
Full Flush: 4l to 6l
Half flush: 2l to 3l
- NF approved stop valve with 10 years warranty
- 10 years warranty for flexible hoses, approved by KIWA and WRAS.
- Successful leakage and pressure tests, Styrofoam insulation against condensation.
- Pre-assembled discharge elbow \varnothing 90 mm with reducer \varnothing 100 or \varnothing 110 mm.
- Silent hydraulic fill valve (16 dB) - EN 14124, Class I
- NF certified filling valve
- 5 years guarantee, except rubber parts
- Without control plate

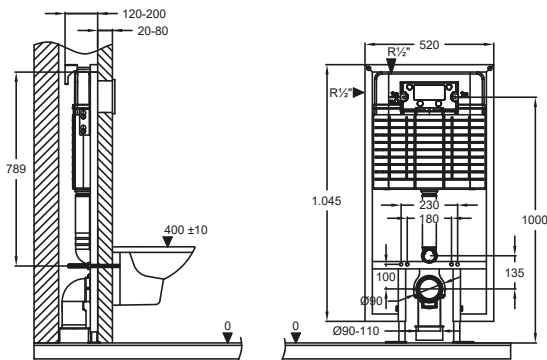

5 YEARS WARRANTY



EASY INSTALLATION



SILENT

51031 •
 PROMICRO CONCEALED CISTERN, SELF STANDING SYSTEM,
 DRYWALL APPLICATION, FOR WALL HUNG WC (80 MM)

51026 •
 SENSE PROMICRO CONCEALED CISTERN,
 SELF STANDING SYSTEM, DRYWALL APPLICATION,
 FOR WALL HUNG WC (80 MM)

- CE, EN 14055 Quality certificate
- Supporting frame for drywall application, tested at 400 kg (EN 997)
- Pre-installed self-standing dual flush concealed cistern, 80 mm
- Adjustable Dual Flush;
 Full Flush: 4 l to 6l,
 Half flush: 2lt to 3l
- NF approved stop valve with 10 years warranty
- 10 years warranty for flexible hoses, approved by KIWA and WRAS
- Successful leakage and pressure tests, Styrofoam insulation against condensation
- Pre-assembled discharge elbow Ø 90 mm with reducer Ø 100 or Ø110 mm
- Silent hydraulic fill valve (16 dB) - EN 14124, Class I
- NF certified filling valve
- 5 years guarantee, except rubber parts
- Without control plate

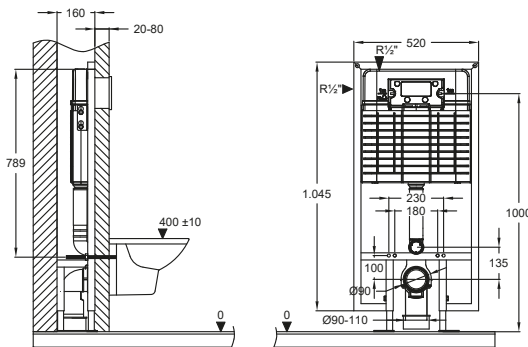

5 YEARS WARRANTY

EASY INSTALLATION

SILENT

51032 •
 PROMICRO CONCEALED CISTERN, BACK TO BACK SYSTEM,
 DRYWALL APPLICATION, FOR WALL HUNG WC (80 MM)

51027 •
 SENSE PROMICRO CONCEALED CISTERN,
 BACK TO BACK SYSTEM, DRYWALL APPLICATION,
 FOR WALL HUNG WC (80 MM)

- CE, EN 14055 Quality certificate
- Supporting frame for drywall application, tested at 400 kg (EN 997).
- Back to back system for hotels and hospitals with single drain, 80 mm . Complete solution size is 200 mm
- Adjustable Dual Flush;
 Full Flush: 4l to 6l
 Half flush: 2l to 3l
- NF approved stop valve with 10 years warranty,
- 10 years warranty for flexible hoses, approved by KIWA and WRAS
- Successful leakage and pressure tests, Styrofoam insulation against condensation
- Pre-assembled discharge elbow Ø 90 mm with reducer Ø 100 or Ø110 mm.
- Silent hydraulic fill valve (16 dB) - EN 14124, Class I
- NF certified filling valve
- 5 years guarantee, except rubber parts
- Without control plate

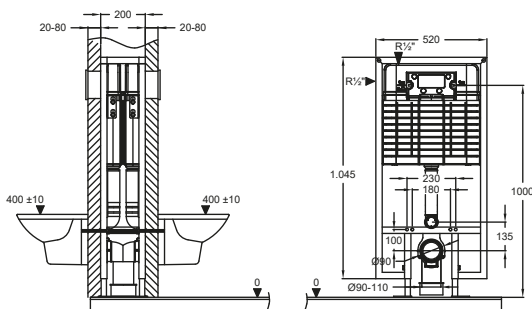

5 YEARS WARRANTY



EASY INSTALLATION



SILENT

51029 •
 PROMICRO CONCEALED CISTERN, IN WALL SYSTEM,
 FOR SQUATING PAN (80 MM)

51024 •
 SENSE PROMICRO CONCEALED CISTERN,
 IN WALL SYSTEM,
 FOR SQUATING PAN (80 MM)

- CE, EN 14055 Quality certificate
- In wall system for squatting pans concealed cistern and self standing WC Pan , 80 mm
- Adjustable Dual Flush;
 Full Flush: 4l to 6l,
 Half flush: 2l to 3l
- NF approved stop valve with 10 years warranty,
- 10 years warranty for flexible hoses, approved by KIWA and WRAS
- Successful leakage and pressure tests, Styrofoam insulation against condensation
- Silent hydraulic fill valve (16 dB) - EN 14124, Class I
- NF certified filling valve
- 5 years guarantee, except rubber parts
- Without control plate

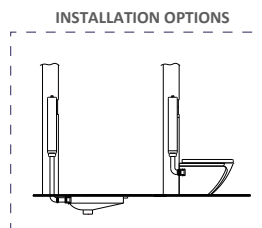
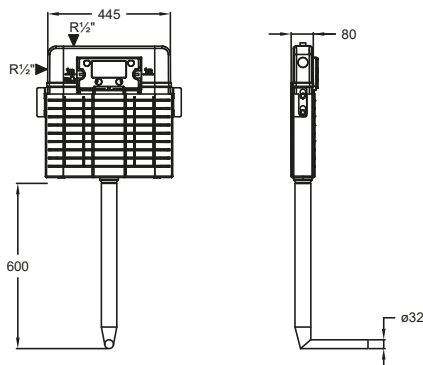

5 YEARS WARRANTY



EASY INSTALLATION



SILENT

50159 •

HERO CONCEALED CISTERN 120 MM,
WALL MOUNTED SYSTEM, DRYWALL APPLICATION,
FOR WALL HUNG WC (120 MM)

51001 •

SENSE HERO CONCEALED CISTERN 120 MM,
WALL MOUNTED SYSTEM, DRYWALL APPLICATION,
FOR WALL HUNG WC (120 MM)

- CE, EN 14055 Quality certificate
- Supporting frame for drywall application, tested at 400 kg (EN 997)
- Dual flush concealed cistern, 120 mm
- Adjustable Dual Flush;
Full Flush: 4l to 6l,
Half flush: 2l to 3l
- NF approved stop valve with 10 years warranty
- 10 years warranty for flexible hoses, approved by KIWA and WRAS
- Successful leakage and pressure tests, Styrofoam insulation against condensation
- Silent hydraulic fill valve (16 dB) - EN 14124, Class I
- NF certified filling valve
- 5 years guarantee, except rubber parts
- Without control plate

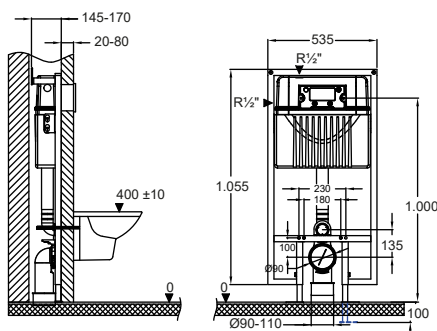

INNOVATIONS ON CONCEALED CISTERN

FRAME INSTALLATION



- The steel profiles are cut with a laser cutting machine so the frame is one piece. There is no open corner making it more resistant to corrosion.



- For easier and faster installation the depth is adjusted by nut and screw.
- The wall connection part is made of reinforced plastic.

2 YEARS WARRANTY



SENSE

● 23546

○ 23545

The SENSE panel provides a non touch system to avoid contact with bacteria.

The SENSE system is driven by 4 batteries placed in the panel , so there is no need for electrical installation.

The system is designed to provide 100,000 cycles of perfect service with the same battery.

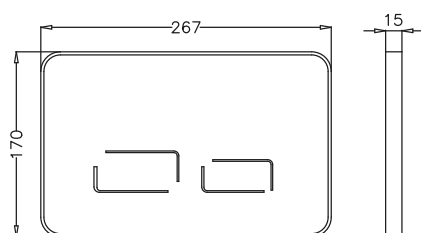
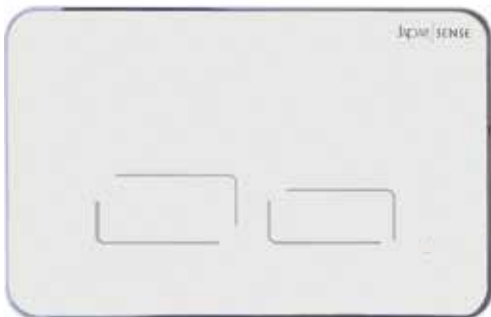
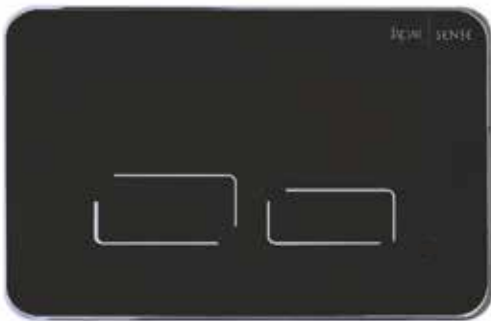



CONTROL PLATES

DIANA

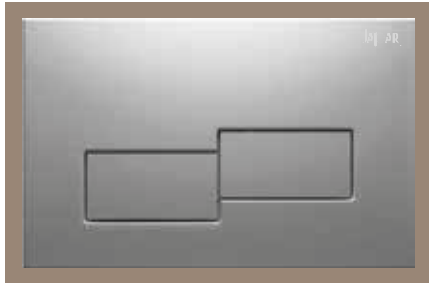

500292 • Matt Chrome

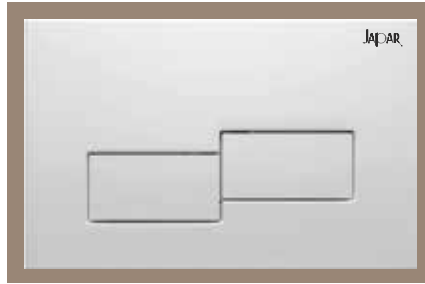

500293 • White

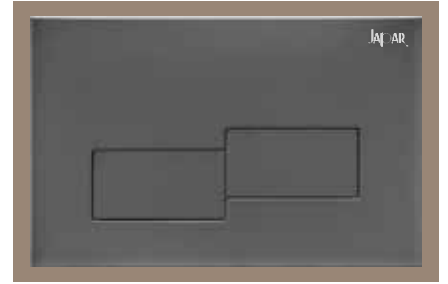

500294 • Gloss Chrome



500295 • Black

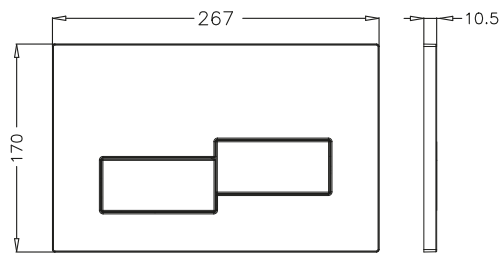

SERENITY



500288 • Matt Chrome



500289 • White



500290 • Gloss Chrome



500291 • Black

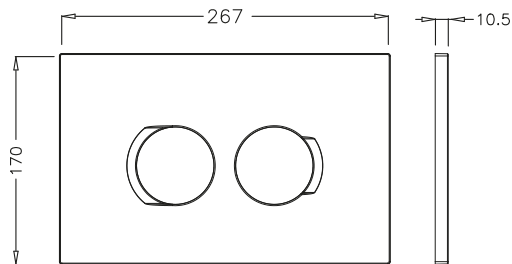

CONTROL PLATES



TEOS

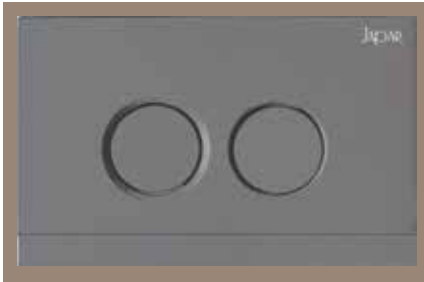

23809 • Matt Chrome



500022 • White



500024 • Gloss Chrome



500023 • Black

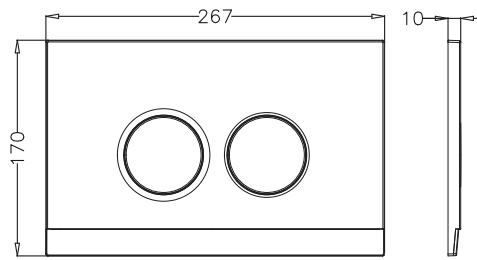

KLAROS

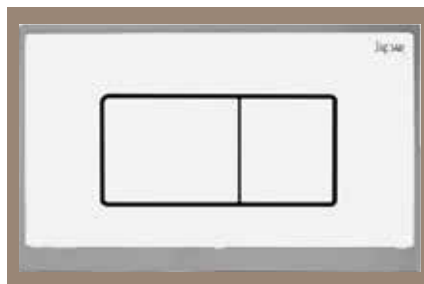

23773 • White - Gloss Chrome

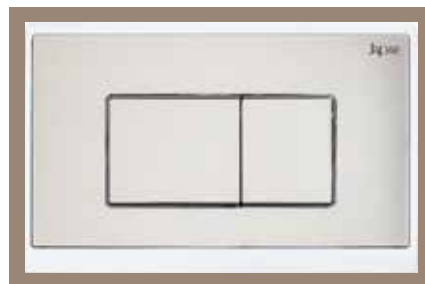

23783 • Gloss Chrome - White

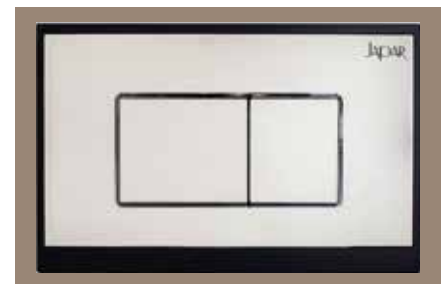

500021 • Gloss Chrome - Black

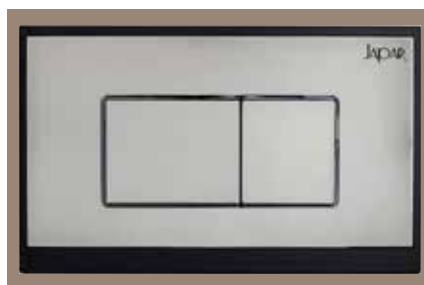

500019 • Matt Chrome - Soft Black



500020 • Black - Gloss Chrome

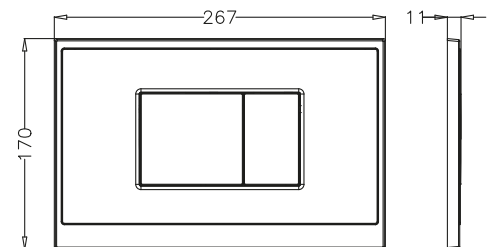



CONTROL PLATES

ZENO

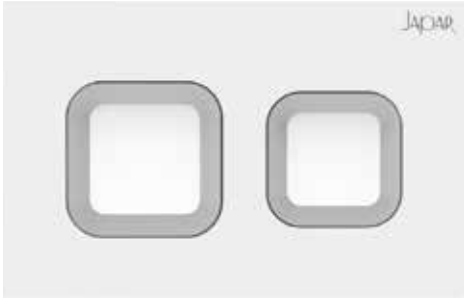

500144 • White - Matt Chrome

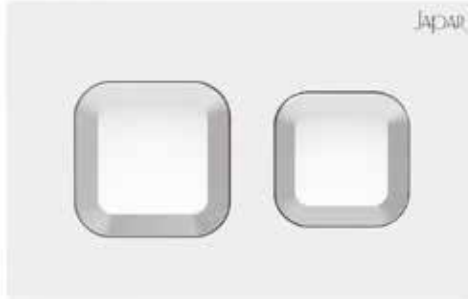

500145 • White - Gloss Chrome

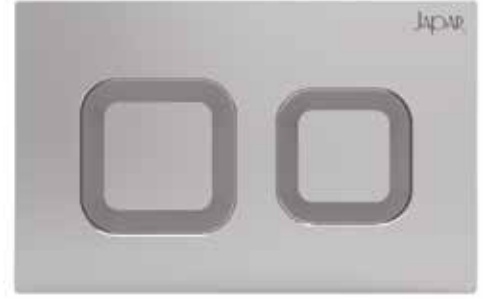

500146 • Gloss - Matt Chrome

OTTO



23235 • Matt - Gloss Chrome



23237 • White - Gloss Chrome



23234 • Gloss - Matt Chrome

ANTI-VANDAL



500042 • Stainless Steel

- 4 mm. Thickness
- 304 Stainless Steel Material
- Anti-Vandalism

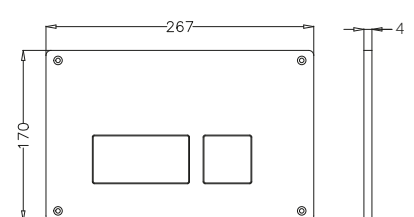
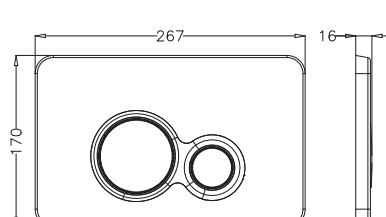
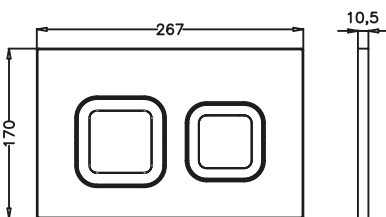

CONTROL PLATES



EGE



23150 • Matt Chrome



23152 • White



23151 • Gloss Chrome

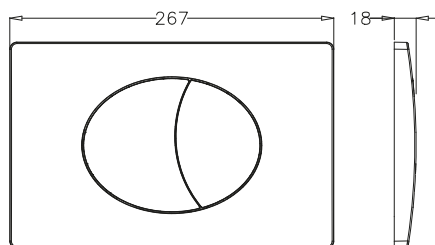

PULSE

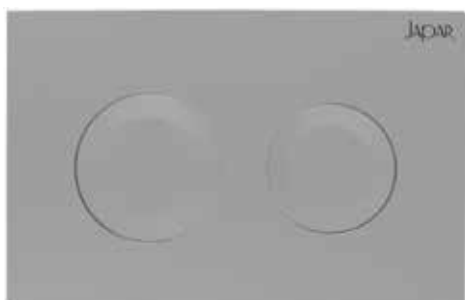

500148 • Matt Chrome



500147 • White



500149 • Gloss Chrome

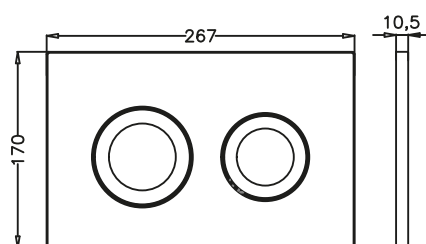



SMALL SIZE CONTROL PLATES

CARIBBEAN

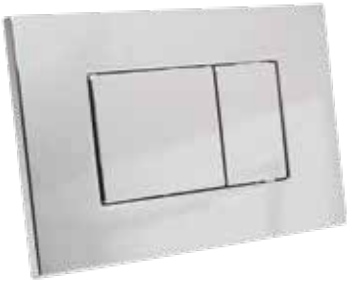

23754 • Matt Chrome

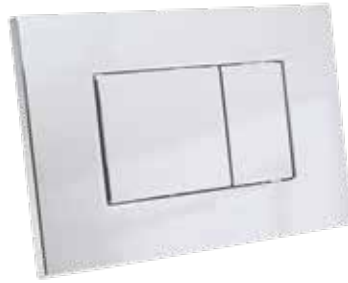

23752 • White

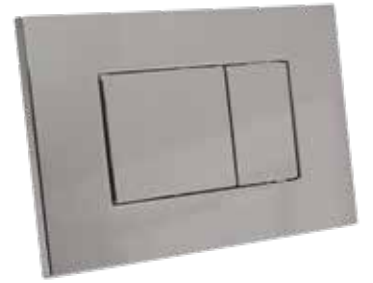

23720 • Gloss Chrome



23753 • Matt Black

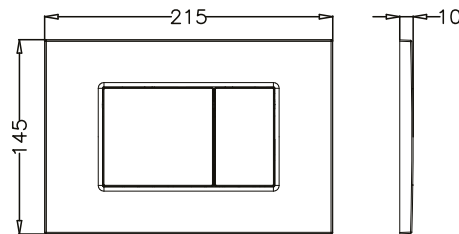

MAJORCA



23757 • Matt Chrome



23755 • White



23721 • Gloss Chrome



23756 • Matt Black

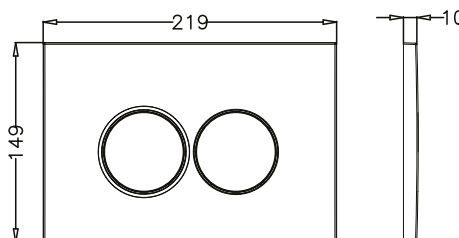

* Caribbean and Majorca small size control plates are only compatible with Hero 120 mm Concealed Cistern.



FLUSHING TANKS

INTERNAL MECHANISMS

FILL VALVES

51036 MERCURY
START-STOP



• Pcs in package : 10

- Suitable for Eastern type toilets.
- The interruption system saves water and conserves natural resources
The start button discharges water
The stop button ends water discharge.
- Installation is simple, all fixing elements are included.
- 2 side water inlet connection 1/2" (3/8" size is optional)
- Valve entrance : 1/2" Filling valve is tested with 0,1 and 10 bars.
Volume: 6L
- TS EN 14055 Certificate.

51038 MERCURY
DUAL FLUSH



• Pcs in package : 10

- Water saving dual flush system
- Easy installation, connection and fixing parts included
- Styrofoam insulation against condensation
- Silent and fast filling with Shock Stop Fill Valve
- Adjustable discharge mechanism between 3-6 l
- Chrome plated Push-Button
- 2 side water inlet connection 1/2" (3/8" size is optional)
- Filling valve is tested with 0,1 and 10 bars
- 6 l volume Polypropylen 'PP' tank
- TS EN 14055 Certificate

51037 MERCURY
STANDARD USE



• Pcs in package : 10

- Pull down High Use flush system with elegant form
- Easy installation, connection and fixing parts included
- Styrofoam insulation against condensation
- Silent and fast filling with Shock Stop Fill Valve
- 2 side water inlet connection 1/2" (3/8" size is optional)
- Filling valve is tested with 0,1 and 10 bars
- 6 l volume Polypropylen 'PP' tank
- TS EN 14055 Certificate

50130 ATLAS START-STOP



• Pcs in package : 10

- Exposed Flushing Cistern with START - STOP water economy button.
- Flushing volume between 6 and 9 l.
- Sytrofoam insulation against condensation.
- Quiet and fast water re-filling.
- Fill valve pressure range 0,1 - 10 bar.
- Water supply connection left and right, entrance 1/2".
- EN 14055 Certificate

50132 ATLAS DUAL FLUSH



• Pcs in package : 10

- Exposed Flushing Cistern with DUAL flush water saving system.
- Flushing volume adjustable 3/6 l or 4,5/9 l.
- Sytrofoam insulation against condensation.
- Chrome plated dual flush button.
- Quiet and fast water re-filling.
- Fill valve pressure range 0,1 - 10 bar.
- Water supply connection left and right, entrance 1/2".
- EN 14055 Certificate

50131 ATLAS STANDARD USE



• Pcs in package : 10

- Pull down High Use Flush Tank with elegant form.
- Atlas High can operate at any height.
- Installation is simple all the fixing elements are included.
- Sytrofoam insulation against condensation.
- Shock - Stop filling valve produced from POM material.
- Valve outlet: 1/2" Volume: 6 - 7,5 - 9 L
- Jointed hose pipe adapter.
- EN 14055 Certificate.



EASY INSTALLATION



SILENT

50720 TELESKOPIC 3/8"
(BRASS CONNECTION)
TELESKOPIC 1/2"
(PLASTIC CONNECTION)

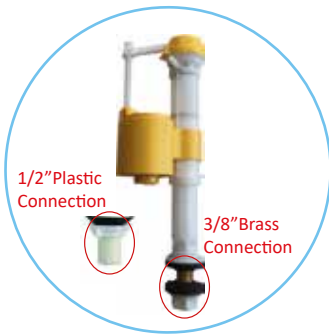

- Height adjustment 170-280 mm between fill valve and body
- Instant shut-off, pilot system, precision fill valve
- Silent and boost charge
- Filtered water inlet, 3/8" brass connection
- Durable plastic POM material
- TS EN 14124 and KIWA Certificate
- Tested 0,5 - 16 Bar
- Suitable for Children's toilet

• Pcs in package : 12

50452 DICLE 3/8"
(BRASS CONNECTION)

50476 DICLE 1/2"
(PLASTIC CONNECTION)



- Pilot system, precision fill valve
- Silent and boost charge
- Filtered water inlet, 3/8" brass connection, 1/2" plastic connection
- Durable plastic POM material
- Tested 10 Bar
- Compatible with back to wall closets

• Pcs in package : 12

50475 PROFILL 3/8"
(BRASS CONNECTION) 

50471 PROFILL 1/2"
(PLASTIC CONNECTION)

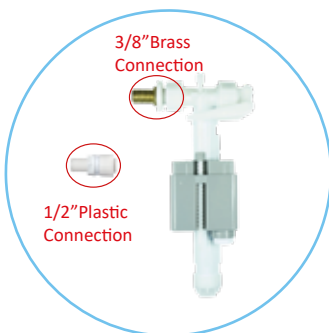

- TS EN 14124, Class I.
- Silent hydraulic fill valve Class II EN 14124 tested by CSTB.
- Instant shut-off, pilot system, precision fill valve
- Silent and boost charge
- Filtered water inlet, 3/8" brass connection, 1/2" plastic connection
- Durable plastic POM material
- Tested 0,5 - 16 Bar

• Pcs in package : 12

50406 SHOCK 3/8"

50407 SHOCK 1/2"



- Silent and fast filling, instant water cut-off system with styrofoam
- 1/2" and 3/8" plastic connection
- Durable plastic POM material
- Tested 10 Bar
- Compatible with plastic cisterns.

• Pcs in package : 12

INTERNAL MECHANISMS

5 YEARS WARRANTY



EASY INSTALLATION



SILENT



STAINLESS STEEL

52013 DOGA START-STOP



• Pcs in package : 12

- EPDM, long life rubber sealing
- Suitable for ceramic cistern with hole diameter of 40 mm
- Silent and fast filling with Dicle fill valve
- Start-Stop push flush system
- Adjustable height for easy installation of flush and push tool
- Ease of assembly and replacement through 2 piece fill valve and 2 piece drain set
- Perfect design that can adapt from children's closets, to the largest cisterns
- 3/8" filtered brass connection

50209 GAP DUAL FLUSH



• Pcs in package : 12

- EPDM, long life rubber sealing
- Suitable for ceramic cistern with hole diameter of 40 mm.
- Silent and fast filling with Dicle fill valve
- Adjustable ABS discharge mechanism between 3-4,5 l and 6-9 l
- 3/8" filtered brass connection
- NF approved discharge mechanism.

50207 ANADOLU PUSH FLUSH



• Pcs in package : 12

- EPDM, long life rubber sealing
- Suitable for ceramic cistern with hole diameter of 40 mm
- Silent and fast filling with Dicle fill valve
- Push discharge system
- Adjustable ABS discharge mechanism between 3-4,5 l and 6-9 l
- 3/8" filtered brass connection



EASY INSTALLATION



SILENT



STAINLESS STEEL

50206 MARS PUSH FLUSH



• Pcs in package : 12

- EPDM, long life rubber sealing
- Suitable for ceramic cistern with hole diameter of 40 mm
- Silent and fast filling with Telescopic fill valve approved by KIWA
- Easy installation
- ABS discharge mechanism
- 3/8" filtered brass connection

50208 KARADENIZ PULL FLUSH



• Pcs in package : 12

- EPDM, long life rubber sealing
- Suitable for ceramic cistern with hole diameter of 40 mm
- Silent and fast filling with Dicle fill valve
- Pull discharge system
- Easy installation
- ABS discharge mechanism
- 3/8" filtered brass connection

50204 EQUINOX DUAL FLUSH



kiwa **NF**

• Pcs in package : 12

- EPDM, long life rubber sealing
- Suitable for ceramic cistern with hole diameter of 40 mm
- Silent and fast filling with Telescopic fill valve
- Tested with 0,5 - 16 Bar
- Adjustable ABS discharge mechanism between 3-4,5 l and 6-9 l
- TS EN 14124 Certificate
- KIWA certified fill valve, NF certified discharge mechanism
- 3/8" filtered brass connection
- Suitable for Children's toilet



SIPHONS

SIPHONS

50601 BOTTLE SIPHON FOR WASHBASIN 1 ¼"



• Pcs in package : 50

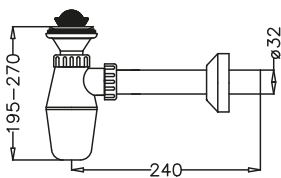

- Plastic cup, stainless steel screw and floor strainer
- Ø65 strainer
- Polypropylene "PP" material

50603 ACCORDION FLEXIBLE SIPHON FOR WASHBASIN AND SINK 1 ¼"



• Pcs in package : 75

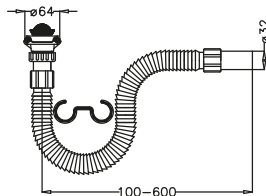

- Fixing hanger to keep the shape
- Flexible hose with easy installation
- Ø65 strainer
- Polypropylene "PP" material

50625 ACCORDION URINAL SIPHON



• Pcs in package : 30

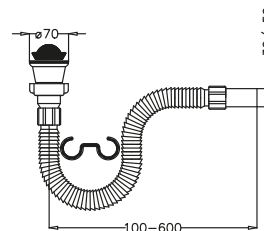

- Fixing hanger to keep the shape
- Flexible hose with easy installation
- Polypropylene "PP" material

50604 URINAL SIPHON



• Pcs in package : 24

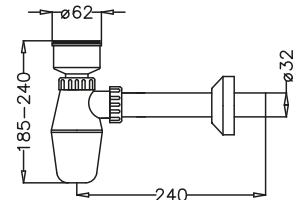

- Rotating head
- Easy to open and clean with spring loaded filter system
- Ø50- Ø32 strainer
- Polypropylene "PP" material

SIPHONS

50610 ACCORDION WASHBASIN AND SINK SIPHON Ø32

50611 ACCORDION WASHBASIN AND SINK SIPHON Ø50



• Pcs in package : 40

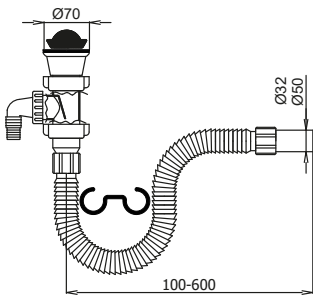

- The washing machine outlet is placed before the siphon to prevent smell.
- A valve inside the dishwasher outlet prevents water from the dishwasher overflowing into the sink.
- Ø70 strainer
- Polypropylene "PP" material

560017 ACCORDION SHOWER TRAY SIPHON Ø50

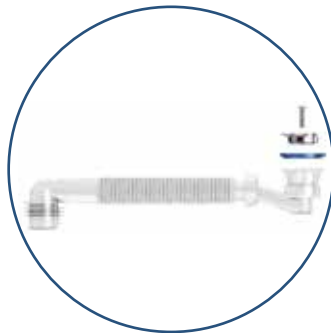

• Pcs in package : 25

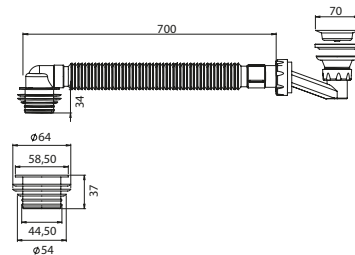

- Accordion system with stainless steel screw and floor strainer
- Ø50 outlet and 65 mm height
- Polypropylene "PP" material

50605 ACCORDION WASHBASIN SIPHON Ø32

50607 ACCORDION WASHBASIN SIPHON Ø50



• Pcs in package : 50

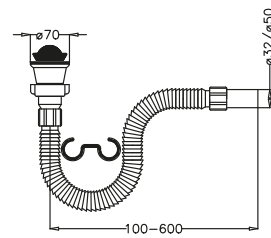

- Suitable with washing machine connecting part
- Ø70 strainer
- Polypropylene "PP" material

50768 FLEXIBLE PAN CONNECTOR



• Pcs in package : 30

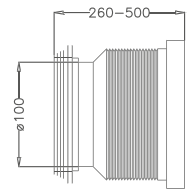

- Flexible and extendable pipe to connect the toilet bowl
- Ø100 outlet



+90 (533) 582 25 20

www.japar.com.tr

 / japarplastik

 / Japar

 / Japar Plastik

**JAPAR İNŞAAT MALZ.
GIDA AMBALAJ
SAN. ve TİC. A.Ş.**

Factory :

 İnönü Mahallesi
139 Sokak No:56
Ayrancılar-Torbali
İZMİR / TÜRKİYE

 +90 232 854 62 00

 +90 232 854 60 50

 info@japar.com.tr

Sales Office :

 Atatürk Cad.
İDTM İş Blokları
A3 Blok 15/450
Bakırköy
İSTANBUL / TÜRKİYE

 +90 212 465 21 72